



USER MANUAL

Smart True HEPA Air Purifier

Product Series: Core 300S

Model: Core 300S

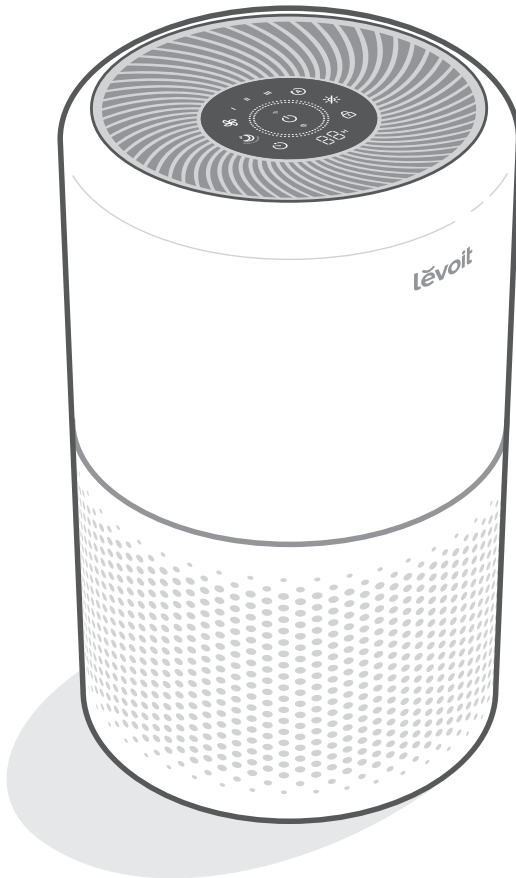

Questions or Concerns?

Please contact us Mon–Fri, 9:00 am–5:00 pm PST/PDT at support@levoit.com or at **(888) 726-8520**.

Table of Contents

| | |
|---|----|
| Package Contents | 2 |
| Specifications | 2 |
| Safety Information | 3 |
| Getting to Know Smart Your Air Purifier | 4 |
| Controls | 5 |
| Getting Started | 6 |
| Using Your Smart Purifier | 7 |
| About the Filter | 11 |
| Levoit Replacement Filters | 12 |
| Care & Maintenance | 13 |
| Troubleshooting | 15 |
| Warranty Information | 19 |
| Customer Support | 20 |

Package Contents

- 1 × Smart Air Purifier
- 1 × True HEPA 3-Stage Original Filter
(Pre-Installed)
- 1 × User Manual
- 1 × Quick Start Guide

Specifications

| | |
|----------------------|--|
| Power Supply | AC 120V, 60Hz |
| Rated Power | 23W |
| Ideal Room Size | 219 ft ² / 20 m ² Note: Effective for larger rooms, but purification will take longer. |
| CADR (CFM) | 141 CFM / 240 m ³ /h |
| Operating Conditions | Temperature: 14°–104°F / -10°–40°C |
| | Humidity: < 85% RH |
| Noise Level | 22–50dB |
| Standby Power | < 2W |
| Dimensions | 8.7 × 8.7 × 14.2 in / 22 × 22 × 36 cm |
| Weight | 5.95 lb / 2.7 kg |

Note: To access additional smart functions, download the free VeSync app (see page 7).

READ AND SAVE THESE INSTRUCTIONS

SAFETY INFORMATION

To reduce the risk of fire, electric shock, or other injury, follow all instructions and safety guidelines.

General Safety

- **Only** use your air purifier as described in this manual.
- **Do not** use without removing the plastic wrap from the filter. The air purifier will not filter air, and may overheat, causing a fire hazard.
- **Do not** use the air purifier outdoors.
- Keep the air purifier away from water, and wet or damp areas. **Never** place in water or liquid.
- **Do not** use in excessively humid areas.
- Keep the air purifier away from heat sources.
- **Do not** use where combustible gases, vapors, metallic dust, aerosol (spray) products, or fumes from industrial oil are present.
- Keep 5 ft / 1.5 m away from where oxygen is being administered.
- Supervise children when they are near the air purifier.
- **Do not** place anything into any opening in the air purifier.
- **Do not** sit or place heavy objects on the air purifier.
- Keep the inside of the air purifier dry. To prevent moisture buildup, avoid placing in rooms with major temperature changes or underneath air conditioners.
- **Always** unplug the air purifier before servicing (such as changing the filter).
- **Do not** use the air purifier if it is damaged or not working correctly, or if the cord or plug is damaged. **Do not** try to repair it yourself. Contact **Customer Support** (see page 20).
- **WARNING:** To reduce the risk of fire or electric shock, **do not** use this air purifier with any solid-state speed controls (such as a dimmer switch).
- Not for commercial use. Household use **only**.
- This appliance is not intended for used by persons (including children) with reduced physical, sensory or mental capabilities, or lack of experience and knowledge, unless they have

been given supervision or instruction concerning use of the appliance by a person responsible for their safety.

- Children should be supervised to ensure that they do not play with the appliance.
- Cleaning and user maintenance shall not be made by children without supervision.

Power & Cord

- Keep the air purifier near the outlet it is plugged into.
- **Never** place the cord near any heat source.
- **Do not** cover the cord with a rug, carpet, or other covering. **Do not** place the cord under furniture or appliances.
- Keep the cord out of areas where people walk often. Place the cord where it will not be tripped over.
- This appliance has a polarized plug (one blade is wider than the other). To reduce the risk of electric shock, this plug is intended to fit in a polarized outlet only one way. If the plug does not fit fully in the outlet, reverse the plug. If it still does not fit, contact a qualified electrician. **Do not** attempt to defeat this safety feature.
- If the supply cord is damaged, it must be replaced by the manufacturer, its service agent or similarly qualified persons in order to avoid a hazard.

Electromagnetic Fields (EMF)

Your Levoit air purifier complies with all standards regarding electromagnetic fields (EMF). If handled properly and according to the instructions in this user manual, the appliance is safe to use based on scientific evidence available today.

GETTING TO KNOW YOUR SMART AIR PURIFIER

- A. Fan Speed Indicators
- B. Fan Speed Button
- C. On/Off Button
- D. Sleep Mode Button
- E. Timer Button
- F. Timer Indicator
- G. Wi-Fi® Indicator
- H. Auto Mode Button
- I. Air Quality Indicator Rings
- J. Display Off Button
- K. Check Filter Indicator
- L. Display Lock Button
- M. Air Outlets
- N. Housing
- O. Air Inlets
- P. AirSight™ Plus Laser Dust Sensor
- Q. Anti-Skid Pads
- R. Filter Cover
- S. True HEPA 3-Stage Original Filter

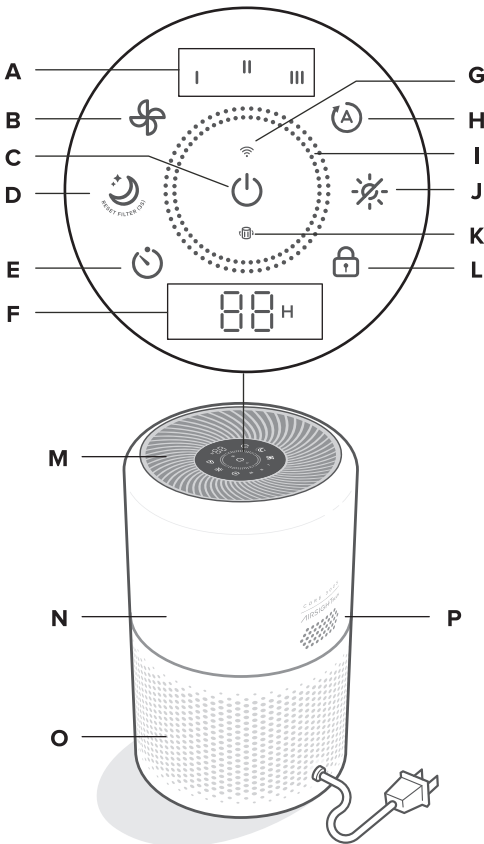

Back

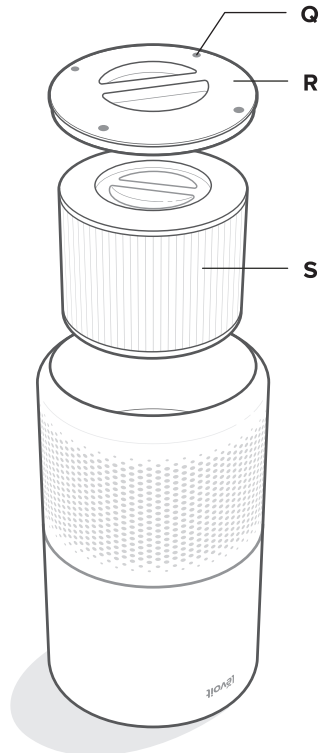

Front, upside down

CONTROLS



On/Off Button

- Turns the air purifier on/off.
- Press and hold to configure the air purifier. See the VeSync in-app instructions for more information.



WiFi Indicator

- Turns on, off, or blinks to indicate pairing status. See the VeSync in-app instructions for more information.



Fan Speed Button

- Cycles through fan speeds: I (low), II (medium), and III (high).
- Tapping the Fan Speed Button while the air purifier is in Sleep Mode or Auto Mode will exit that mode.



Sleep Mode Button

- Turns Sleep Mode on (see page 8).
- Press and hold for 3 seconds to reset the Check Filter Indicator.



Timer Button

- Cycles through timer options (see page 9).
- Holding  for 2 seconds allows you to cycle through the timer options faster.



Auto Mode

- Turns Auto Mode on (see page 8).



Display Off Button

- Turns the display off (see page 9).
- Tap any button (except ) to turn the display back on.



Display Lock Button

- Prevents current settings from being changed (see page 9).
- Blinks when any other button is tapped to indicate that Display Lock is on.



Check Filter Indicator

- Lights up when the filter should be checked (see **Check Filter Indicator**, page 13).
- Reset the Check Filter Indicator by pressing and holding the Sleep Mode button for 3 seconds.

GETTING STARTED

1. Flip the air purifier over. Twist the filter cover counterclockwise and remove it. [Figure 1.1]

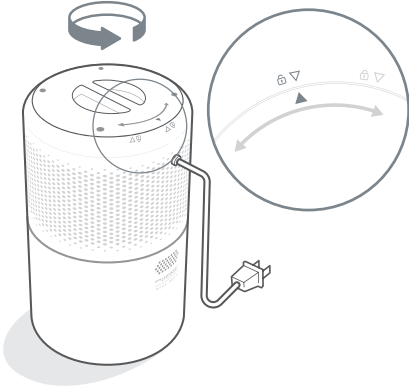

Figure 1.1

3. Replace the filter cover and twist clockwise to lock. [Figure 1.3]



Figure 1.3

2. Remove the filter from its plastic packaging and place the filter back into the air purifier with the handle facing up. [Figure 1.2]

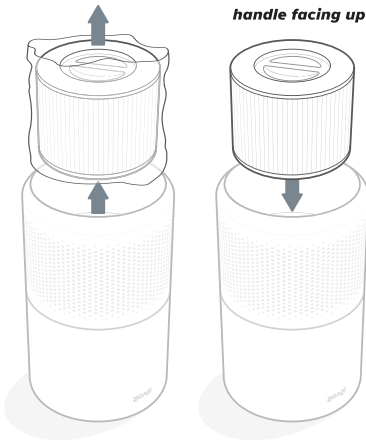

Figure 1.2

4. Place the purifier on a flat, stable surface with the display facing up. Allow at least 15 inches / 38 cm of clearance on all sides. Keep away from anything that would block airflow, such as curtains. [Figure 1.4]

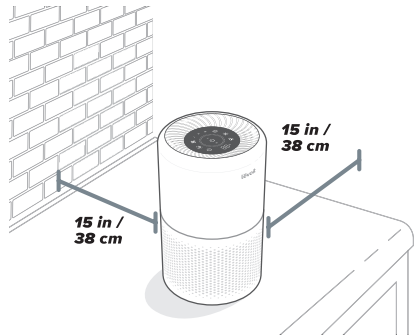

Figure 1.4

VeSync App Setup

1. To download the VeSync app, scan the QR code or search “VeSync” in the Apple App Store® or Google Play Store.
2. Open the VeSync app. **Log In** or **Sign Up**.
3. Follow the in-app instructions to set up your smart air purifier.



Note:



- To disconnect Wi-Fi, press and hold the On/Off button for 15 seconds until the Wi-Fi indicator turns off. This will restore the smart air purifier's default settings and disconnect it from the VeSync app.
- To reconnect, please follow the instructions in the VeSync app for adding a device.

Connect with Amazon Alexa or Google Assistant™

You can use the VeSync app to connect your smart air purifier to **Amazon Alexa** or **Google Assistant™**. Please follow in-app instructions to set up your voice assistant.

Note: You must create your own VeSync account to access voice assistants.

USING YOUR SMART AIR PURIFIER

1. Plug in and tap  to turn on the air purifier. The fan will start on level I.
2. Optionally, tap  to change fan speed between I, II, and III.

Note:

- The indicators are not buttons and cannot be used to change the fan speed.
- The fan speed indicators will light up when active.
- Fan speed III is the loudest, but cleans air the quickest.
- For best results, or to address a specific air quality issue such as smoke, run the air purifier at high speed (level III) for 15–20 minutes before using a lower speed.
- To effectively clean air, keep windows and doors closed while the air purifier is on.

3. Tap  to turn off the air purifier.

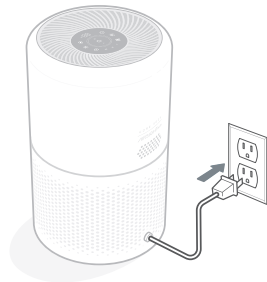

Figure 2.1

USING YOUR PURIFIER (CONT.)

Memory Function

When the air purifier is plugged in and turned off, it will remember its previous fan speed, Sleep Mode, Auto Mode, Display Lock, and Display Off settings.

When the air purifier is unplugged and turned off, it will only remember its previous fan speed, Sleep Mode, and Auto Mode.

Note: *The air purifier will remember the last timer setting chosen (1–12 hours), but it will not automatically resume the timer. You will need to reselect the timer after the air purifier is turned back on.*

Sleep Mode

Sleep Mode operates quietly by using a fan speed lower than fan speed 1.

1. Tap  to turn Sleep Mode on/off.
2. Sleep Mode will turn off the display after 3 seconds if no other buttons are pressed.

Note:

- *When the display is turned off, press any button (except ) to turn the display back on. If you don't press another button, the display will turn off again after 3 seconds.*
- *The Check Filter Indicator will still turn on and stay on if it's time to check your filter (see page 13).*

Auto Mode

Auto Mode uses AirSight Plus, a smart laser dust sensor inside the air purifier, to adjust the fan speed automatically based on air quality. For example, if the air quality is bad, the fan will automatically be set to high speed.

| Air Quality Indicator Chart | | |
|-----------------------------|-------------|---------------------|
| Indicator Color | Air Quality | Auto Mode Fan Speed |
| Blue | Very Good | Sleep Mode |
| Green | Good | Low |
| Orange | Moderate | Medium |
| Red | Bad | High |

Note:

- *The air purifier will take 5 seconds to detect the air quality each time it is turned on. During this time, the air quality indicator rings will be blue. After 5 seconds, the air quality indicator rings will change color based on the detected air quality.*
- *The VeSync app also supports additional auto modes: Quiet Auto Mode and Efficient Auto Mode (see page 10).*

Standby Mode

The air purifier is in Standby Mode when it is turned off, but plugged in.

Note: *Display lock can be used while the air purifier is in Standby Mode to keep the air purifier from turning back on. The laser dust sensor will still detect the surrounding air quality and give you updates in the VeSync app.*



USING YOUR PURIFIER (CONT.)

Timer

You can set a timer for 1–12 hours.

1. Tap  repeatedly to select a time in 1-hour increments. When you've chosen your time, the display will flash 3 times, and the timer will start automatically.

Note:





- *The timer indicator will count down from your selected time, and the air purifier will turn off when it's finished.*
 - *Press and hold  for 2 seconds to cycle through timer options faster.*
 - *The timer indicator cannot be used to select a time.*
 - *The indicator will light up when active.*
2. When the timer is finished, the air purifier will turn off.
 3. To cancel a timer, tap  until the display reads "--H" and flashes 3 times.

Note:

- *You can change the fan speed at any time while the timer is on.*
- *The timer will restart if the time is changed.*
- *The air purifier will remember the last timer setting while turned off, but the timer will be cancelled and need to be restarted.*
- *You can set a timer for 1–24 hours in the VeSync app.*

Display Off



This turns off the display lights on the air purifier, including button lights and indicator lights (except the Check Filter Indicator).

1. Press  to turn off the display.
2. Tap any button (except  or ) to temporarily turn the display back on. If you don't press another button, the display will turn back off after 3 seconds.
3. Press  to turn the display back on. The display will stay on.

Note: *The Check Filter Indicator will still turn on and stay on if it's time to check your filter (see page 13).*

Display Lock

When the air purifier is on, you can lock the display to prevent settings from being accidentally changed. Buttons will not respond to being tapped.

1. Tap and hold  for 3 seconds to lock/unlock the display.
2.  will turn light up, and  will flash 3 times.

Note:

- *When the display is locked,  will flash 3 times if you tap other buttons on the display.*
- *Display lock can still be used when the air purifier is in Standby Mode.*

USING YOUR PURIFIER (CONT.)

VeSync App Functions

The VeSync app allows you to access additional smart air purifier functions, including those listed below. As the app develops, more features may become available.

Remote Control

- Change any air purifier settings through the app, even while Display Lock is on.

Air Quality Updates

- View real-time PM2.5 updates in the app.
- See your air quality history for the previous week.

Auto Mode

- Access additional Auto Modes: Quiet Auto Mode and Efficient Auto Mode.
- Quiet Auto Mode never uses the highest fan speed to avoid making too much noise.
- Efficient Auto Mode lets you choose the size of the area you want to purify. The air purifier will use the highest fan speed to clean the air in that area. Once your air is clean, it will lower to the fan speed best suited to the selected room size.

Schedules

- Create and customize schedules for your air purifier to match your routines.

Timer Function

- Set a timer between 1–24 hours.

Filter Replacement Info

- Keep tabs on the remaining filter life by checking the filter life percentage in the app.
- Shop for replacement filters.

ABOUT THE FILTER

The air purifier uses a 3-stage filtration system to purify air.

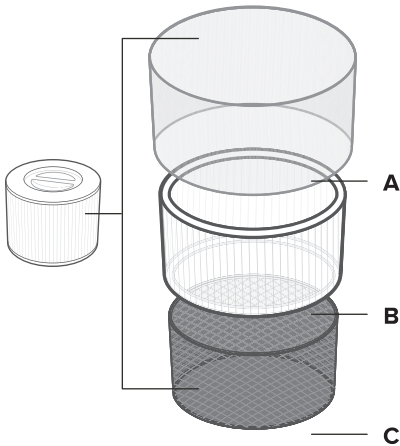

A. Pre-Filter

- Captures large particles such as dust, lint, fibers, hair, and pet fur.
- Maximizes the filter's life by protecting it.

B. H13 True HEPA Filter

- Captures at least 99.97% of airborne particles 0.3 microns (μm) in size.
- Filters small particles such as fine dust, parts of smoke, and allergens such as pollen and dander.

C. High-Efficiency Activated Carbon Filter

- Physically adsorbs smoke, odors, and fumes.
- Filters compounds such as formaldehyde, benzene, ammonia, hydrogen sulfide, and volatile organic compounds (VOCs).

Note: Levoit air purifiers filter airborne particles 0.3 microns in size. Arovast Corporation makes no claims that this air purifier helps reduce the COVID-19 virus.

Clean Air Delivery Rate

This air purifier has a Clean Air Delivery Rate of 141 cubic feet per minute (CFM), or 240 m^3/h .

Clean Air Delivery Rate (CADR) measures the efficiency of an air purifier by indicating the volume of clean air that an air purifier produces per minute. This is based on removal of dust, pollen, and smoke, which are the 3 most common indoor air pollutants. The higher the CADR, the more particles the air purifier will remove and the larger the area it can clean. The rating is measured at the air purifier's highest speed.

Air Change per Hour

The air change rate is how many times all of the air in a room can be purified (or "changed") by the air purifier in 1 hour. Air changes per hour (ACH) are calculated on the recommended room size assuming 8 ft / 2.4 m ceilings. For smaller rooms, the air change per hour will increase. This air purifier has an air change per hour of 5, which means it can change air 5 times per hour at the max speed in a single, closed room up to 219 ft^2 / 20 m^2 . The air purifier is effective for larger rooms, but air purification will take longer, with fewer air changes per hour.

Note: To effectively clean air, keep windows and doors closed while the air purifier is on.

Humidity

Moisture may damage the filter. This air purifier should be used in an area with a humidity level below 85% RH. If you use the air purifier in excessively humid areas, the surface of the filter may become moldy.

Note: Water or moisture will allow mold to grow. To solve a mold problem, get rid of the source of the moisture and clean up the mold.

LEVOIT REPLACEMENT FILTERS

Your air purifier comes with a Levoit True HEPA 3-Stage Original Filter. You can also choose a replacement filter with additional capabilities. Choose the filter best suited to the environment of your home.



Core 300-RF

Levoit True HEPA 3-Stage Original Filter

Traps fine particles such as dust, pollen, and pet dander while adsorbing common household smells such as pet odors and cooking smells.

Best used for: allergies, dust, and light odors



Core 300-RF-PA

Levoit True HEPA 3-Stage Pet Allergy Filter

Get all the benefits of the Original Filter with the addition of a High-Efficiency Activated Carbon Filter, which is very effective for strong smells and is customized to address pet odors and cooking smells.

Best used for: pet allergies, bad-smelling rooms



Core 300-RF-TX

Levoit True HEPA 3-Stage Toxin Absorber Filter

Get all the benefits of the Original Filter with the addition of a High-Efficiency Activated Carbon Filter, which is very effective for strong smells and is customized to address air pollution, cigarette smoke, vehicle exhaust, toxic gases and fumes, volatile organic compounds (VOCs), and smoke from wildfires.



Best used for: high air pollution, smoke

CARE & MAINTENANCE

Cleaning the Smart Air Purifier

- Unplug before cleaning.
- Wipe the outside of the air purifier with a soft, dry cloth. If necessary, wipe the housing with a damp cloth, then immediately dry.
- Vacuum the inside of the air purifier.
- **Do not** clean with abrasive chemicals or flammable cleaning agents.

Check Filter Indicator







 will light up as a reminder to check the filter. You will also receive a notification from VeSync when it's time to check your filter, and you can view your filter life percentage in the app at any time. Depending on how often you use the air purifier, the indicator should turn on within 6–8 months. You may not need to replace your filter yet, but you should check it when  turns on.

Cleaning the Filter

The outer pre-filter should be cleaned every 2–4 weeks to increase efficiency and extend the life of your filter. Clean the pre-filter using a soft brush or vacuum hose to remove hair, dust, and large particles. **[Figure 3.1] Do not** clean the filter with water or other liquids.

Resetting the Check Filter Indicator

Reset the Check Filter Indicator when:

- A.  lights up red.**
1. Replace the filter (see page 14).
 2. Turn on the air purifier.
 3. Press and hold  for 3 seconds.
 4.  will turn off when successfully reset.
- B. The filter was changed before  lit up.**
1. Press and hold  for 3 seconds.
 2. The  will flash for 3 seconds.
 3.  will turn off when successfully reset.

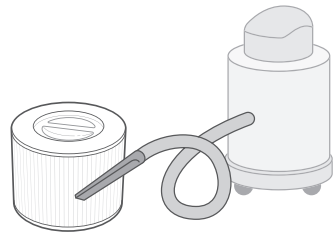



Figure 3.1

| Filter | When to Clean | How to Clean | When to Replace |
|-------------------------------------|---------------------|---|-----------------|
| Pre-Filter | Every 2–4 weeks | Use a soft brush or vacuum hose [Figure 3.1] | 6–8 months |
| True HEPA & Activated Carbon Filter | Do not clean | | |

CARE & MAINTENANCE (CONT.)

When Should I Replace the Filter?

The filter should be replaced every 6–8 months. You may need to replace your filter earlier or later depending on how often you use your air purifier. Using your air purifier in an environment with relatively high pollution may mean you will need to replace the filter more often, even if  is off.

You may need to replace your filter if you notice:

- Increased noise when the air purifier is on
- Decreased airflow
- Unusual odors
- A visibly clogged filter

Note:

- To maintain the performance of your air purifier, **only** use official Levoit filters. For more information, contact Customer Support.
- Remember to reset  after changing the filter (see page 13).

Cleaning the AirSight Plus Laser Dust Sensor

The AirSight Plus Laser Dust Sensor can be blocked by dust, which affects the sensor's accuracy. Clean the sensor every 3 months. Using your air purifier in an environment with more dust may mean you will need to clean the sensor more often.

1. Unplug the air purifier.
2. Place the end of a vacuum cleaner over the sensor openings. *[Figure 3.3]*
3. Turn the vacuum on for at least 10 seconds to clean out dust.

Replacing the Filter

1. Unplug the air purifier. Flip the air purifier over and remove the filter cover (see **Getting Started**, page 6).
2. Remove the old filter.
3. Clean out any remaining dust or hair inside the air purifier using a vacuum hose. **Do not** use water or liquids to clean the air purifier. *[Figure 3.2]*
4. Unwrap the new filter and place it into the housing (see **Getting Started**, page 6).
5. Replace the cover. Plug in the air purifier.
6. Reset the Check Filter Indicator (see page 13).

Storage

If not using the air purifier for an extended period of time, wrap both the air purifier and the filter in plastic packaging and store in a dry place to avoid moisture damage.

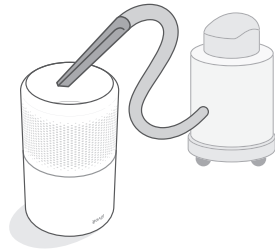

Figure 3.2

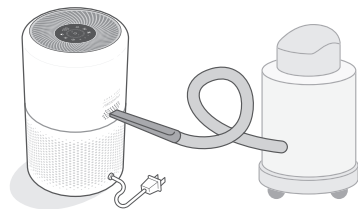











Figure 3.3

TROUBLESHOOTING

| Problem | Possible Solution |
|---|---|
| <p>Air purifier will not turn on or respond to button controls.</p> | <p>Plug in the air purifier.</p> |
| | <p>Check to see if the power cord is damaged. If it is, stop using the air purifier and contact Customer Support (see 20).</p> |
| | <p>Plug the air purifier into a different outlet.</p> |
| | <p>The air purifier may be malfunctioning. Contact Customer Support (see 20).</p> |
| <p>Airflow is significantly reduced.</p> | <p>Make sure the filter is removed from its packaging and properly in place (see page 6).</p> |
| | <p>Tap  to increase the fan speed.</p> |
| | <p>Leave 15 inches / 38 cm of clearance on all sides of the air purifier.</p> |
| | <p>The pre-filter may be clogged by large particles, such as hair or lint, blocking airflow. Clean the pre-filter (see page 13).</p> |
| | <p>Replace the filter (see page 14).</p> |
| <p>Air purifier makes an unusual noise while the fan is on.</p> | <p>Make sure the filter is properly in place with plastic packaging removed (see page 6).</p> |
| | <p>Make sure the air purifier is operating on a hard, flat, level surface.</p> |
| | <p>Replace the filter (see page 14).</p> |
| | <p>The air purifier may be damaged, or a foreign object may be inside. Stop using the air purifier and contact Customer Support (see page 20). Do not try to repair the air purifier.</p> |
| <p>Strange smell coming from the air purifier.</p> | <p>Clean the filter, or replace if necessary.</p> |
| | <p>Contact Customer Support (see 20).</p> |
| | <p>Make sure not to use your air purifier in an area with high humidity or while diffusing essential oils.</p> |

TROUBLESHOOTING (CONT.)

| Problem | Possible Solution |
|--|---|
| <p>Poor air purification quality.</p> | Tap  to increase the fan speed. |
| | Make sure no objects are blocking the sides or top of the air purifier (the inlet or outlet). |
| | Make sure the filter is removed from its packaging and properly in place (see page 6). |
| | Close doors and windows while using the air purifier. |
| | Make sure the room is smaller than 219 ft ² / 20 m ² . The air purifier may not be as effective in larger rooms. |
| | Replace the filter (see page 14). |
| <p> is still on after replacing the filter.</p> | Reset the Check Filter Indicator (see page 13). |
| <p> has not turned on within 8 months.</p> | <p> is a reminder for you to check the filter and will light up based on how much the air purifier has been used (see page 13). If you don't use your air purifier often,  will take longer to turn on.</p> |
| <p> turned on before 6 months.</p> | <p> is a reminder for you to check the filter and will light up based on how much the air purifier has been used (see page 13). If you run your air purifier frequently,  will turn on sooner.</p> |
| <p>Air Quality Indicator always stays red.</p> | The AirSight Plus Laser Dust Sensor may need to be cleaned (see page 14). |
| | If you're using an ultrasonic humidifier near the air purifier, the mist may affect the accuracy of the AirSight Plus Laser Dust Sensor. The sensor will detect the large mist particles, and the Air Quality Indicator may turn red. Avoid using an ultrasonic humidifier near the air purifier, or use a different mode besides Auto Mode. |
| <p>Air Quality Indicator always stays blue, even when the air quality is poor.</p> | The AirSight Plus Laser Dust Sensor detects airborne particles, but it cannot detect gas. Make sure there isn't gas polluting the air. |
| <p>Display shows Error Code "E1".</p> | The motor has malfunctioned. Please contact Customer Support (see page 20). |

If your problem is not listed, please contact **Customer Support** (see 20).

VESYNC APP TROUBLESHOOTING

My air purifier isn't connecting to the VeSync app.

- During the setup process, you must be on a secure 2.4GHz WiFi network. Confirm that the network is working correctly.
- Make sure the WiFi password you entered is correct.
 - There should be no spaces at the beginning or end of the password.
 - Test the password by connecting a different electronic device to the router.
 - If you're manually typing in the SSID and password, double check that both are entered correctly.
- Try moving your air purifier closer to the router. Your phone should be as close as possible to your air purifier.
- Your router may need to be at a higher location, away from obstructions.
- Make sure your air purifier and router are away from appliances (such as microwave ovens, refrigerators, electronic devices, etc.) to avoid signal interference.
- If you're using a VPN, make sure it's turned off while setting up your air purifier.
- Disable portal authentication for your WiFi network. If portal authentication is enabled, the air purifier will not be able to access your WiFi network, and setup will fail.

Note: *Portal authentication means that you need to sign in to your WiFi network through a web page before you can use the Internet.*

My air purifier is offline.

- Make sure the air purifier is plugged in and has power, then refresh the VeSync menu by swiping down on the screen.
- Make sure your router is connected to the internet and your phone's network connection is working.
- Delete the offline air purifier from the VeSync app. Swipe left (iOS®) or tap and hold (Android™), then tap **Delete**. Reconfigure the air purifier with the VeSync app.

Note: *Power outages, internet outages, or changing WiFi routers may cause the air purifier to go offline.*

If your problem is not listed, please contact **Customer Support** (see 20).

ATTRIBUTIONS

Amazon, Alexa, and all related logos are trademarks of Amazon.com, Inc. or its affiliates.

Google, Android, and Google Play are trademarks of Google LLC.

App Store® is a trademark of Apple Inc.

Wi-Fi® is a registered trademark of Wi-Fi Alliance®.

iOS is a registered trademark of Cisco Systems, Inc. and/or its affiliates in the United States and certain other countries.

FEDERAL COMMUNICATION COMMISSION INTERFERENCE STATEMENT

This device complies with Part 15 of the FCC Rules. Operation is subject to the following two conditions:

1. This device may not cause harmful interference, and
2. This device must accept any interference received, including interference that may cause undesired operation.

NOTE: This equipment has been tested and found to comply with the limits for a Class B digital device, pursuant to Part 15 of the FCC Rules. These limits are designed to provide reasonable protection against harmful interference in a residential installation. This equipment generates, uses and can radiate radio frequency energy and, if not installed and used in accordance with the instructions, may cause harmful interference to radio communications. However, there is no guarantee that interference will not occur in a particular installation. If this equipment does cause harmful interference to radio or television reception, which can be determined by turning the equipment off and on, the user is encouraged to try to correct the interference by one or more of the following measures:

- Reorient or relocate the receiving antenna.
- Increase the separation between the equipment and receiver.
- Connect the equipment into an outlet on a circuit different from that to which the receiver is connected.
- Consult the dealer or an experienced radio/TV technician for help.

FCC Caution: Any changes or modifications not expressly approved by the party responsible for compliance could void the user's authority to operate this equipment.

FCC RADIATION EXPOSURE STATEMENT

This equipment complies with FCC radiation exposure limits set forth for an uncontrolled environment. End users must follow the specific operating instructions for satisfying RF exposure compliance. To maintain compliance with FCC RF exposure compliance requirements, please follow operation instructions as documented in this manual. This transmitter must not be co-located or operating in conjunction with any other antenna or transmitter. This equipment should be installed and operated with a minimum distance of 20cm between the radiator and your body. The availability of some specific channels and/or operational frequency bands are country dependent and are firmware programmed at the factory to match the intended destination. The firmware setting is not accessible by the end user.

WARRANTY INFORMATION

| | |
|--|------------------------------|
| Product Name | Smart True HEPA Air Purifier |
| Model | Core 300S |
| <i>For your own reference, we strongly recommend that you record your order ID and date of purchase.</i> | |
| Date of Purchase | |
| Order ID | |

Terms & Policy

Arovast Corporation (“Arovast”) warrants this product to the original purchaser to be free from defects in material and workmanship, under normal use and conditions, for a period of 2 years from the date of original purchase.

Arovast agrees, at our option during the warranty period, to repair any defect in material or workmanship or furnish an equal product in exchange without charge, subject to verification of the defect or malfunction and proof of the date of purchase.

There is no other express warranty. This warranty does not apply:

- If the product has been modified from its original condition;
- If the product has not been used in accordance with directions and instructions in the user manual;
- To damages or defects caused by accident, abuse, misuse or improper or inadequate maintenance;
- To damages or defects caused by service or repair of the product performed by an unauthorized service provider or by anyone other than Arovast;
- To damages or defects occurring during commercial use, rental use, or any use for which the product is not intended;
- To damages or defects exceeding the cost of the product.

Arovast will not be liable for indirect, incidental, or consequential damages in connection with the use of the product covered by this warranty.

This warranty extends only to the original consumer purchaser of the product and is not transferable to any subsequent owner of the product regardless of whether the product is transferred during the specified term of the warranty.

This warranty does not extend to products purchased from unauthorized sellers. Arovast’s warranty extends only to products purchased from authorized sellers that are subject to Arovast’s quality controls and have agreed to follow its quality controls.

All implied warranties are limited to the period of this limited warranty.

This warranty gives you specific legal rights and you may also have other rights which vary from state to state. Some states do not allow the exclusion or limitation of incidental or consequential damages, so the above limitation or exclusion may not apply to you.

If you discover that your product is defective within the specified warranty period, please contact Customer Support via support@levoit.com. **DO NOT** dispose of your product before contacting us. Once our Customer Support Team has approved your request, please return the product with a copy of the invoice and order ID.

Every Levoit product automatically includes a 2-year warranty. To make the customer support process quick and easy, register your product online at www.levoit.com/warranty.

This warranty is made by:

Arovast Corporation
1202 N. Miller St. Suite A
Anaheim, CA 92806

CUSTOMER SUPPORT

If you have any questions or concerns about your new product, please contact our helpful Customer Support Team.

Arovast Corporation

1202 N. Miller St., Suite A
Anaheim, CA 92806

Email: support@levoit.com

Toll-Free: (888) 726-8520

Support Hours

Mon–Fri, 9:00 am–5:00 pm PST/PDT

*Please have your order invoice and order ID ready before contacting Customer Support.



The energy efficiency of this ENERGY STAR certified model is measured based on a ratio between the model's CADR for Smoke and the electrical energy it consumes, or CADR/Watt.



/LEVOITLIFESTYLE



/LEVOIT



/LEVOIT



/LEVOIT



LEVOIT.COM

lëvoit[®]